

Data Mining: Data

Lecture Notes for Chapter 2

Introduction to Data Mining

by

Tan, Steinbach, Kumar

What is Data?

- Collection of data objects and their attributes
- An attribute is a property or characteristic of an object
 - Examples: eye color of a person, temperature, etc.
 - Attribute is also known as variable, field, characteristic, or feature
- A collection of attributes describe an object
 - Object is also known as record, point, case, sample, entity, or instance

Attributes

<i>Tid</i>	Refund	Marital Status	Taxable Income	Cheat
1	Yes	Single	125K	No
2	No	Married	100K	No
3	No	Single	70K	No
4	Yes	Married	120K	No
5	No	Divorced	95K	Yes
6	No	Married	60K	No
7	Yes	Divorced	220K	No
8	No	Single	85K	Yes
9	No	Married	75K	No
10	No	Single	90K	Yes

Objects

Attribute Values

- Attribute values are numbers or symbols assigned to an attribute
- Distinction between attributes and attribute values
 - Same attribute can be mapped to different attribute values
 - ◆ Example: height can be measured in feet or meters
 - Different attributes can be mapped to the same set of values
 - ◆ Example: Attribute values for ID and age are integers
 - ◆ But properties of attribute values can be different
 - ID has no limit but age has a maximum and minimum value

Measurement of Length

- The way you measure an attribute is somewhat may not match the attributes properties.

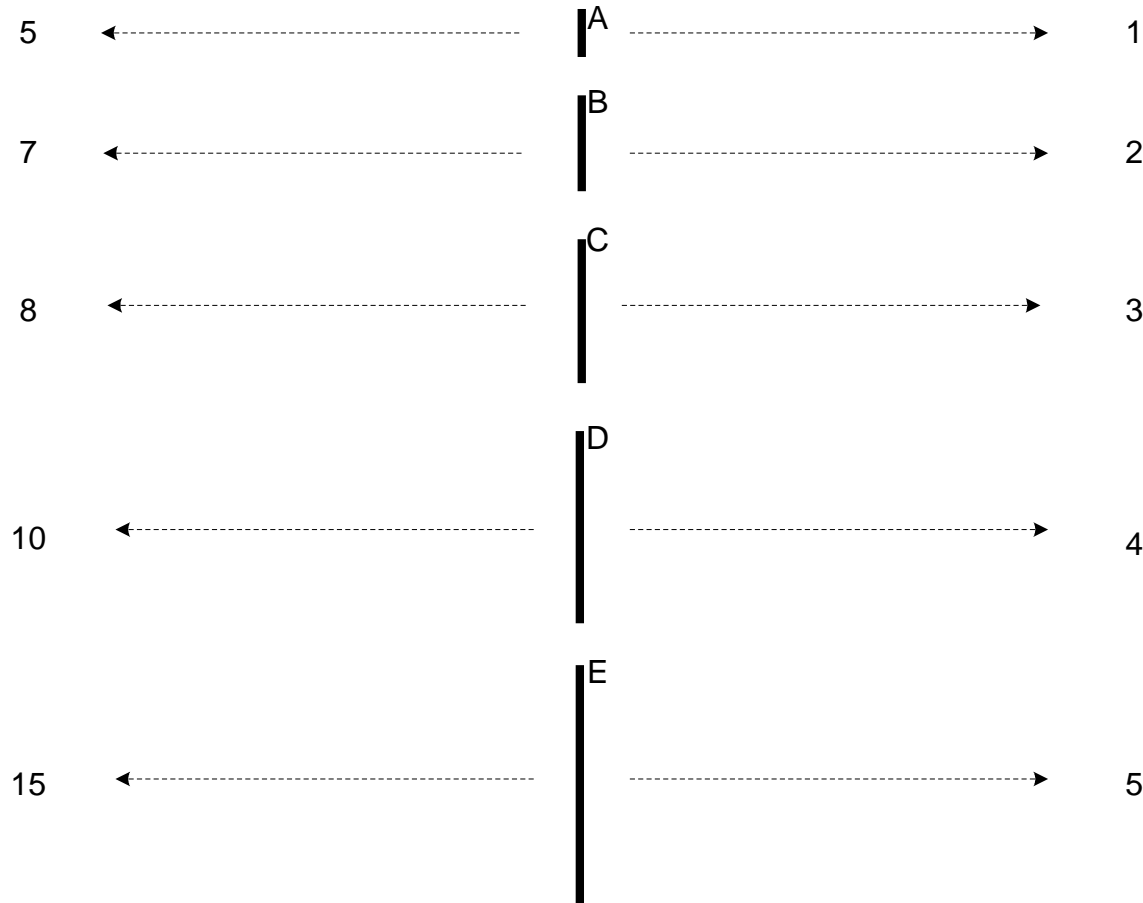

Types of Attributes

- There are different types of attributes
 - **Nominal**
 - ◆ Examples: ID numbers, eye color, zip codes
 - **Ordinal**
 - ◆ Examples: rankings (e.g., taste of potato chips on a scale from 1-10), grades, height in {tall, medium, short}
 - **Interval**
 - ◆ Examples: calendar dates, temperatures.
 - **Ratio**
 - ◆ Examples: length, time, counts

Properties of Attribute Values

- The type of an attribute depends on which of the following properties it possesses:
 - Distinctness: = \neq
 - Order: < >
 - Addition: + -
 - Multiplication: * /

 - Nominal attribute: distinctness
 - Ordinal attribute: distinctness & order
 - Interval attribute: distinctness, order & addition
 - Ratio attribute: all 4 properties

Attribute Type	Description	Examples	Operations
Nominal	The values of a nominal attribute are just different names, i.e., nominal attributes provide only enough information to distinguish one object from another. (=, ≠)	zip codes, employee ID numbers, eye color, sex: { <i>male</i> , <i>female</i> }	mode, entropy, contingency correlation, χ^2 test
Ordinal	The values of an ordinal attribute provide enough information to order objects. (<, >)	hardness of minerals, { <i>good</i> , <i>better</i> , <i>best</i> }, grades, street numbers	median, percentiles, rank correlation, run tests, sign tests
Interval	For interval attributes, the differences between values are meaningful, i.e., a unit of measurement exists. (+, -)	calendar dates, temperature in Celsius or Fahrenheit	mean, standard deviation, Pearson's correlation, <i>t</i> and <i>F</i> tests
Ratio	For ratio variables, both differences and ratios are meaningful. (*, /)	temperature in Kelvin, monetary quantities, counts, age, mass, length, electrical current	geometric mean, harmonic mean, percent variation

Attribute Level	Transformation	Comments
Nominal	Any permutation of values	If all employee ID numbers were reassigned, would it make any difference?
Ordinal	An order preserving change of values, i.e., $new_value = f(old_value)$ where f is a monotonic function.	An attribute encompassing the notion of good, better best can be represented equally well by the values { 1, 2, 3 } or by { 0.5, 1, 10 }.
Interval	$new_value = a * old_value + b$ where a and b are constants	Thus, the Fahrenheit and Celsius temperature scales differ in terms of where their zero value is and the size of a unit (degree).
Ratio	$new_value = a * old_value$	Length can be measured in meters or feet.

Discrete and Continuous Attributes

- Discrete Attribute

- Has only a finite or countably infinite set of values
- Examples: zip codes, counts, or the set of words in a collection of documents
- Often represented as integer variables.
- Note: binary attributes are a special case of discrete attributes

- Continuous Attribute

- Has real numbers as attribute values
- Examples: temperature, height, or weight.
- Practically, real values can only be measured and represented using a finite number of digits.
- Continuous attributes are typically represented as floating-point variables.

Types of data sets

- **Record**

- Data Matrix
- Document Data
- Transaction Data

- **Graph**

- World Wide Web
- Molecular Structures

- **Ordered**

- Spatial Data
- Temporal Data
- Sequential Data
- Genetic Sequence Data

Important Characteristics of Structured Data

- **Dimensionality**
 - ◆ **Curse of Dimensionality**

- **Sparsity**
 - ◆ **Only presence counts**

- **Resolution**
 - ◆ **Patterns depend on the scale**

Record Data

- Data that consists of a collection of records, each of which consists of a fixed set of attributes

<i>Tid</i>	Refund	Marital Status	Taxable Income	Cheat
1	Yes	Single	125K	No
2	No	Married	100K	No
3	No	Single	70K	No
4	Yes	Married	120K	No
5	No	Divorced	95K	Yes
6	No	Married	60K	No
7	Yes	Divorced	220K	No
8	No	Single	85K	Yes
9	No	Married	75K	No
10	No	Single	90K	Yes

Data Matrix

- If data objects have the same fixed set of numeric attributes, then the data objects can be thought of as points in a multi-dimensional space, where each dimension represents a distinct attribute
- Such data set can be represented by an m by n matrix, where there are m rows, one for each object, and n columns, one for each attribute

Projection of x Load	Projection of y load	Distance	Load	Thickness
10.23	5.27	15.22	2.7	1.2
12.65	6.25	16.22	2.2	1.1

Document Data

- Each document becomes a 'term' vector,
 - each term is a component (attribute) of the vector,
 - the value of each component is the number of times the corresponding term occurs in the document.

	team	coach	play	ball	score	game	win	lost	timeout	season
Document 1	3	0	5	0	2	6	0	2	0	2
Document 2	0	7	0	2	1	0	0	3	0	0
Document 3	0	1	0	0	1	2	2	0	3	0

Transaction Data

- A special type of record data, where
 - each record (transaction) involves a set of items.
 - For example, consider a grocery store. The set of products purchased by a customer during one shopping trip constitute a transaction, while the individual products that were purchased are the items.

<i>TID</i>	<i>Items</i>
1	Bread, Coke, Milk
2	Beer, Bread
3	Beer, Coke, Diaper, Milk
4	Beer, Bread, Diaper, Milk
5	Coke, Diaper, Milk

Graph Data

- Examples: Generic graph and HTML Links

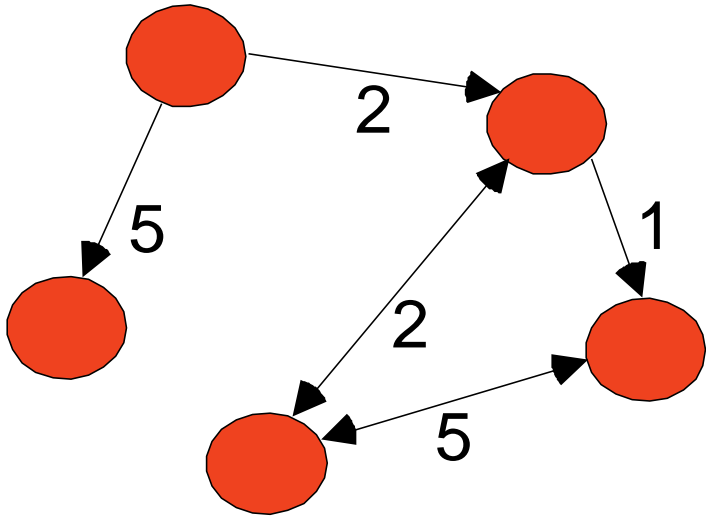

```
<a href="papers/papers.html#bbbb">  
Data Mining </a>  
<li>  
<a href="papers/papers.html#aaaa">  
Graph Partitioning </a>  
<li>  
<a href="papers/papers.html#aaaa">  
Parallel Solution of Sparse Linear System of Equations </a>  
<li>  
<a href="papers/papers.html#ffff">  
N-Body Computation and Dense Linear System Solvers
```

Chemical Data

- Benzene Molecule: C_6H_6

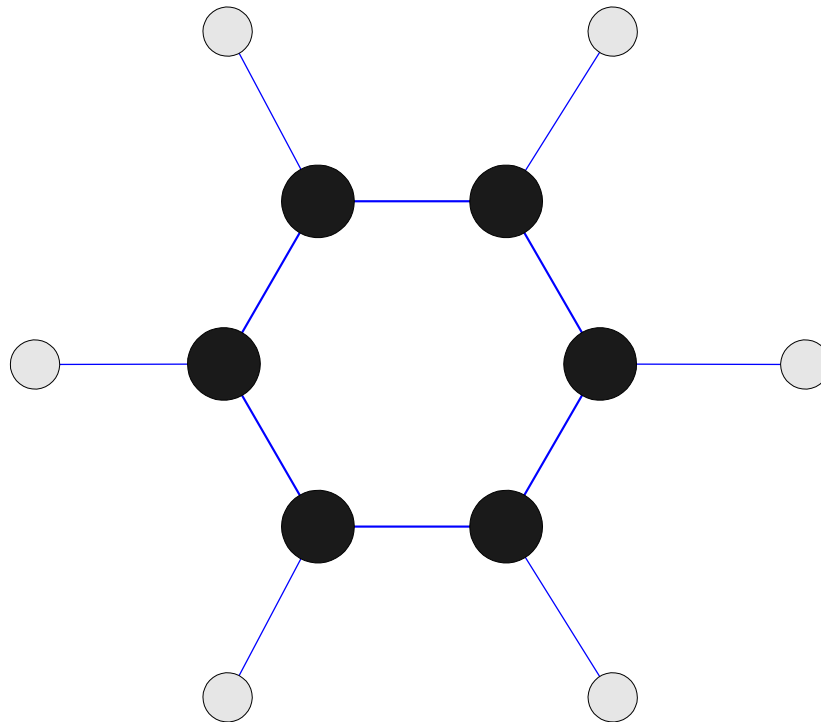

Ordered Data

- Sequences of transactions

Items/Events

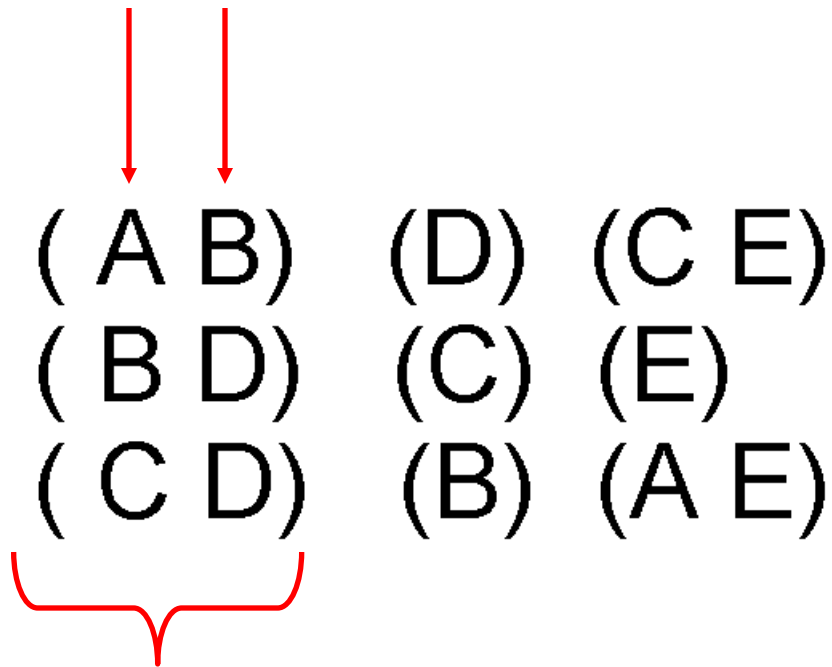

An element of
the sequence

Ordered Data

- Genomic sequence data

**GGTTC CGCCTTCAGCCCCGCGCC
CGCAGGGCCCGCCCCGCGCCGTC
GAGAAGGGCCCGCCTGGCGGGCG
GGGGGAGGCGGGGCCGCCCGAGC
CCAACCGAGTCCGACCAGGTGCC
CCCTCTGCTCGGCCTAGACCTGA
GCTCATTAGGCGGCAGCGGACAG
GCCAAGTAGAACACGCGAAGCGC
TGGGCTGCCTGCTGCGACCAGGG**

Ordered Data

- Spatio-Temporal Data

**Average Monthly
Temperature of
land and ocean**

Jan

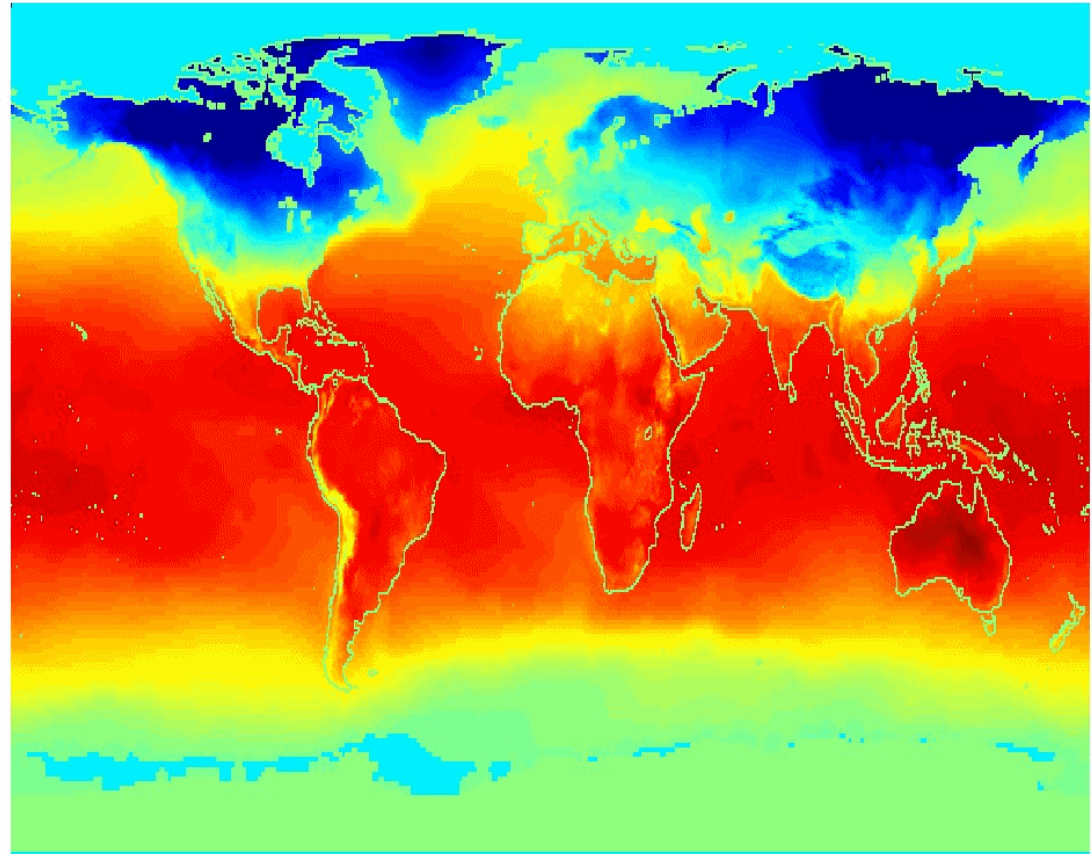

Data Quality

- What kinds of data quality problems?
- How can we detect problems with the data?
- What can we do about these problems?

- Examples of data quality problems:
 - Noise and outliers
 - missing values
 - duplicate data

Noise

- Noise refers to modification of original values
 - Examples: distortion of a person's voice when talking on a poor phone and “snow” on television screen

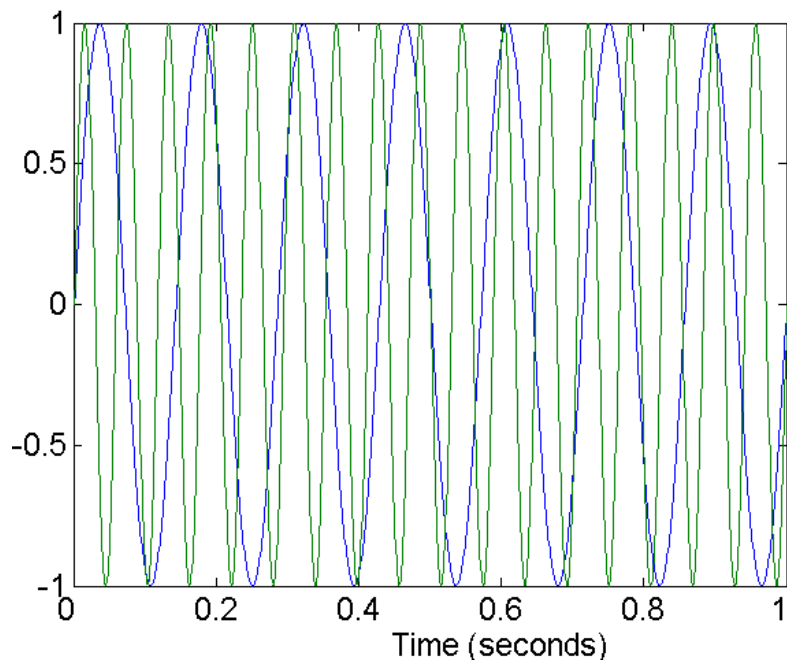

Two Sine Waves

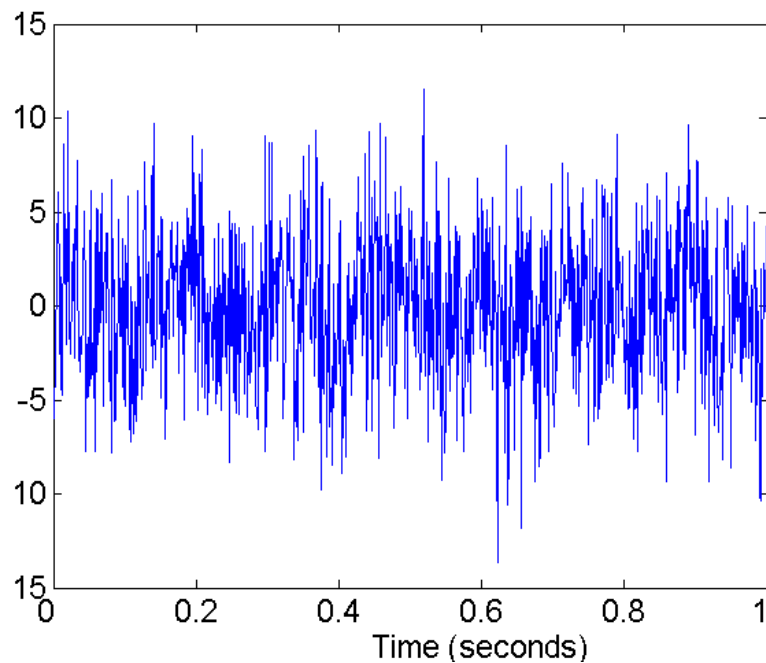

Two Sine Waves + Noise

Outliers

- Outliers are data objects with characteristics that are considerably different than most of the other data objects in the data set

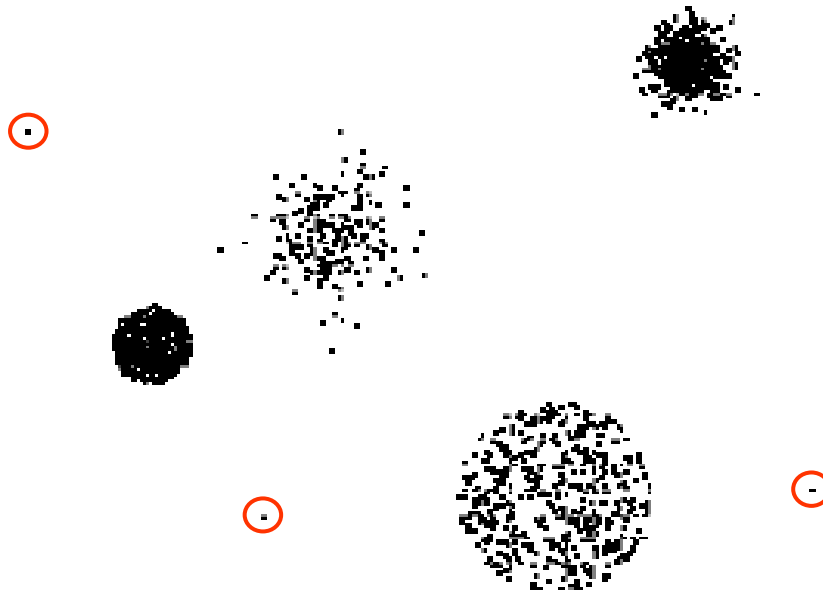

Missing Values

- Reasons for missing values
 - Information is not collected (e.g., people decline to give their age and weight)
 - Attributes may not be applicable to all cases (e.g., annual income is not applicable to children)

- Handling missing values
 - Eliminate Data Objects
 - Estimate Missing Values
 - Ignore the Missing Value During Analysis
 - Replace with all possible values (weighted by their probabilities)

Duplicate Data

- Data set may include data objects that are duplicates, or almost duplicates of one another
 - Major issue when merging data from heterogeneous sources
- Examples:
 - Same person with multiple email addresses
- Data cleaning
 - Process of dealing with duplicate data issues

Data Preprocessing

- Aggregation
- Sampling
- Dimensionality Reduction
- Feature subset selection
- Feature creation
- Discretization and Binarization
- Attribute Transformation

Aggregation

- Combining two or more attributes (or objects) into a single attribute (or object)

- Purpose
 - Data reduction
 - ◆ Reduce the number of attributes or objects
 - Change of scale
 - ◆ Cities aggregated into regions, states, countries, etc
 - More “stable” data
 - ◆ Aggregated data tends to have less variability

Aggregation

Variation of Precipitation in Australia

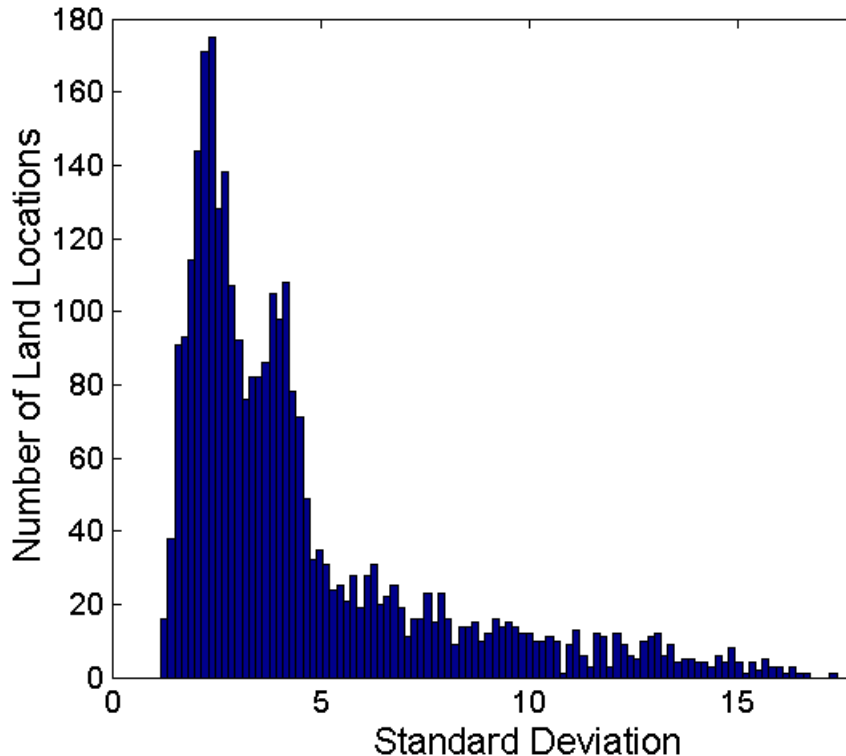

**Standard Deviation of Average
Monthly Precipitation**

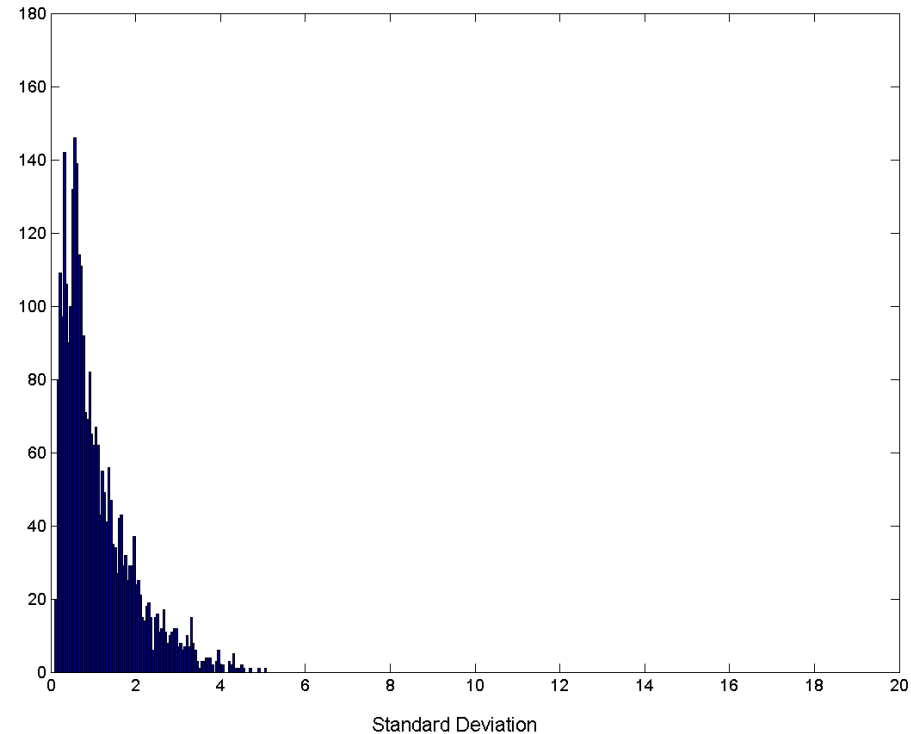

**Standard Deviation of Average
Yearly Precipitation**

Sampling

- **Sampling is the main technique employed for data selection.**
 - It is often used for both the preliminary investigation of the data and the final data analysis.
- **Statisticians sample because **obtaining** the entire set of data of interest is too expensive or time consuming.**
- **Sampling is used in data mining because **processing** the entire set of data of interest is too expensive or time consuming.**

Sampling ...

- The key principle for effective sampling is the following:
 - using a sample will work almost as well as using the entire data sets, if the sample is representative
 - A sample is representative if it has approximately the same property (of interest) as the original set of data

Types of Sampling

- Simple Random Sampling
 - There is an equal probability of selecting any particular item
- Sampling without replacement
 - As each item is selected, it is removed from the population
- Sampling with replacement
 - Objects are not removed from the population as they are selected for the sample.
 - ◆ In sampling with replacement, the same object can be picked up more than once
- Stratified sampling
 - Split the data into several partitions; then draw random samples from each partition

Sample Size

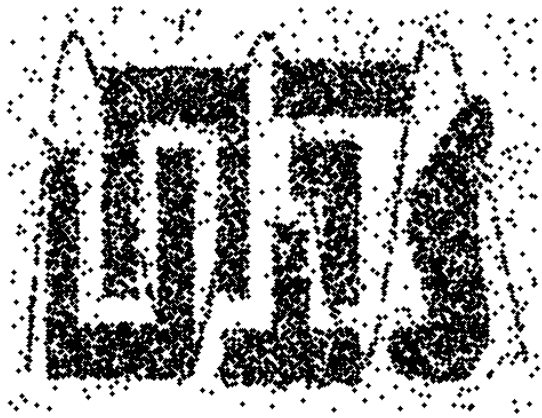

8000 points

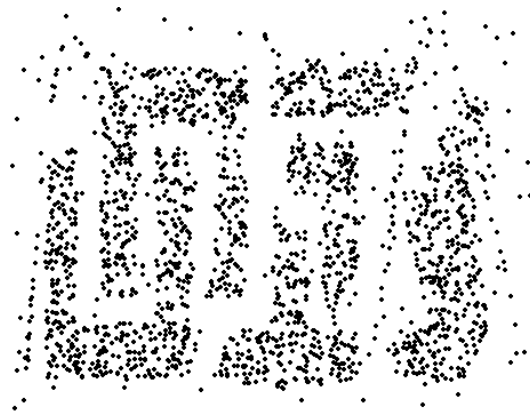

2000 Points



500 Points

Sample Size

- What sample size is necessary to get at least one object from each of 10 groups.

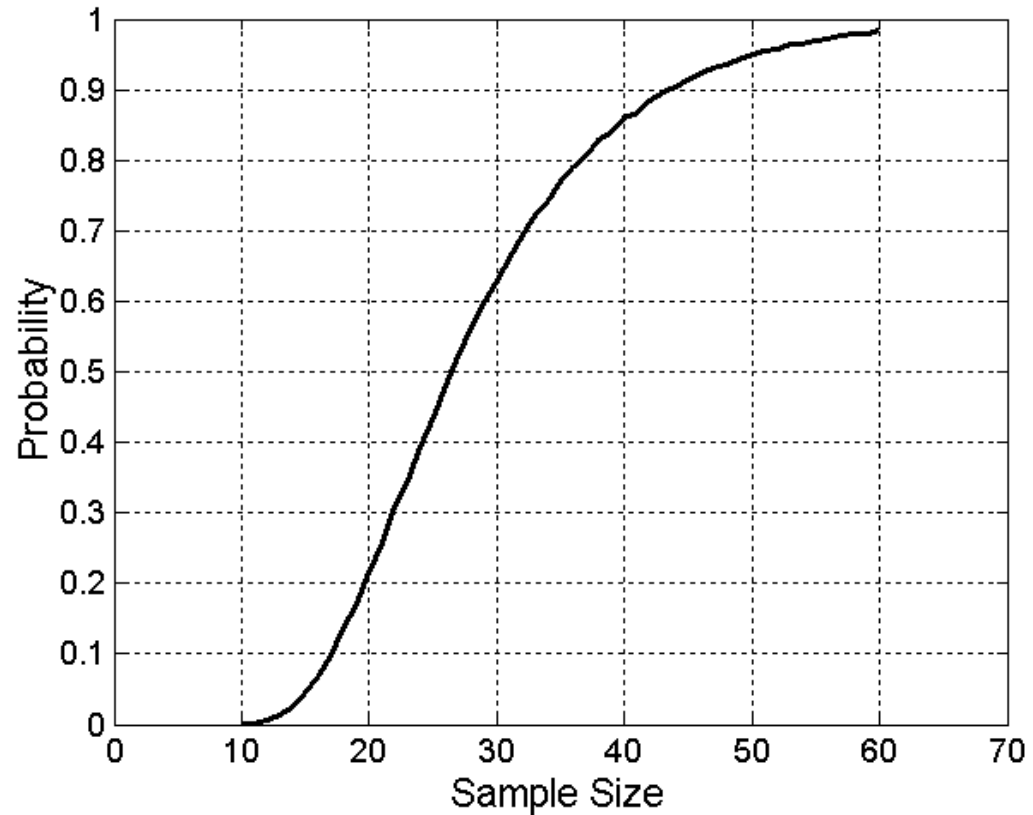

Curse of Dimensionality

- When dimensionality increases, data becomes increasingly sparse in the space that it occupies
- Definitions of density and distance between points, which is critical for clustering and outlier detection, become less meaningful

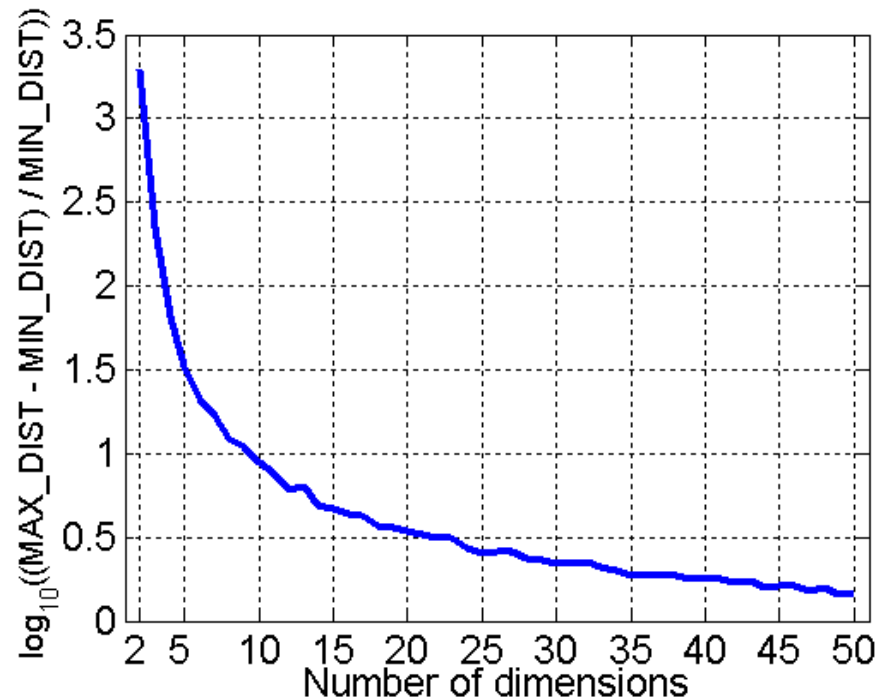

- Randomly generate 500 points
- Compute difference between max and min distance between any pair of points

Dimensionality Reduction

- Purpose:
 - Avoid curse of dimensionality
 - Reduce amount of time and memory required by data mining algorithms
 - Allow data to be more easily visualized
 - May help to eliminate irrelevant features or reduce noise

- Techniques
 - Principle Component Analysis
 - Singular Value Decomposition
 - Others: supervised and non-linear techniques

Dimensionality Reduction: PCA

- Goal is to find a projection that captures the largest amount of variation in data

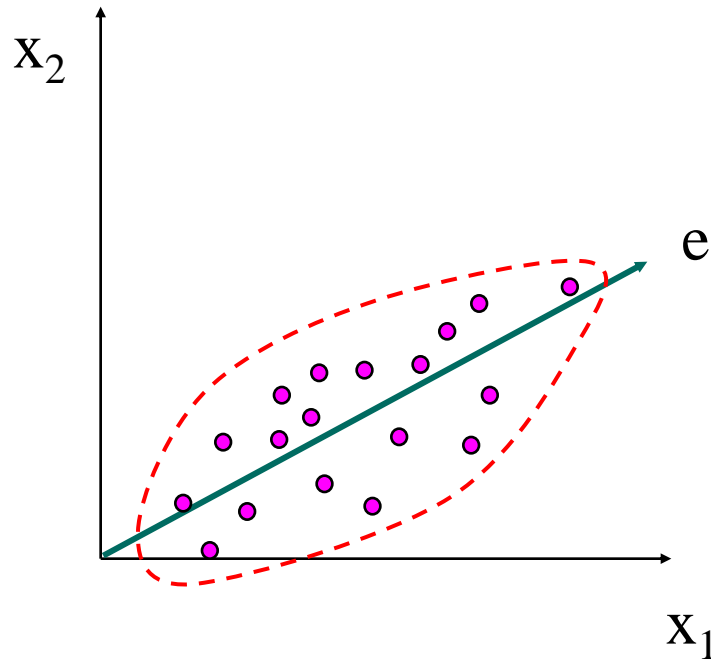

Dimensionality Reduction: PCA

- Find the eigenvectors of the covariance matrix
- The eigenvectors define the new space

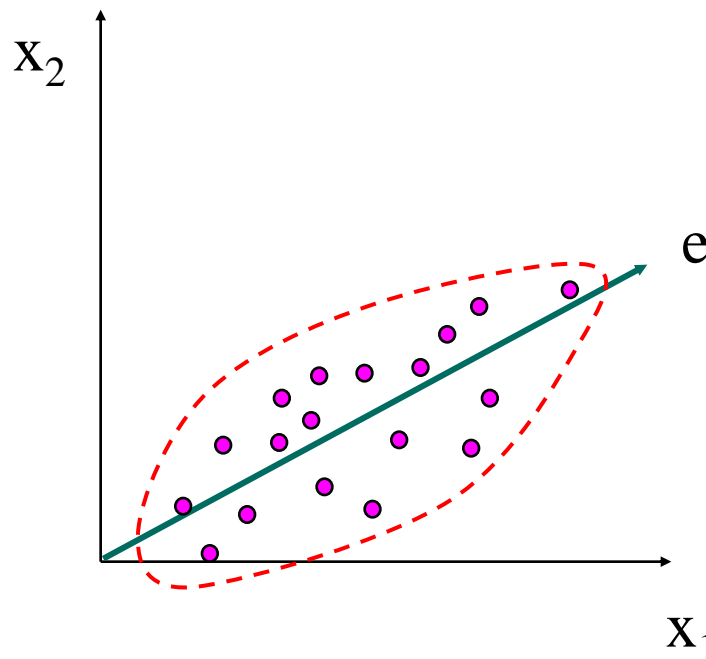

Dimensionality Reduction: ISOMAP

By: Tenenbaum, de Silva,
Langford (2000)

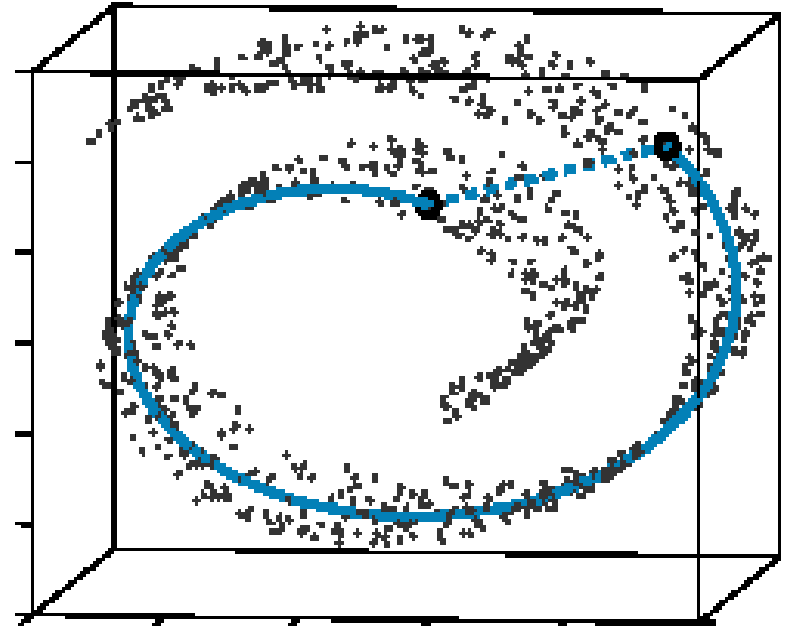

- Construct a neighbourhood graph
- For each pair of points in the graph, compute the shortest path distances – geodesic distances

Dimensionality Reduction: PCA

Dimensions = 206



Feature Subset Selection

- Another way to reduce dimensionality of data
- Redundant features
 - duplicate much or all of the information contained in one or more other attributes
 - Example: purchase price of a product and the amount of sales tax paid
- Irrelevant features
 - contain no information that is useful for the data mining task at hand
 - Example: students' ID is often irrelevant to the task of predicting students' GPA

Feature Subset Selection

- Techniques:
 - Brute-force approach:
 - ◆ Try all possible feature subsets as input to data mining algorithm
 - Embedded approaches:
 - ◆ Feature selection occurs naturally as part of the data mining algorithm
 - Filter approaches:
 - ◆ Features are selected before data mining algorithm is run
 - Wrapper approaches:
 - ◆ Use the data mining algorithm as a black box to find best subset of attributes

Feature Creation

- Create new attributes that can capture the important information in a data set much more efficiently than the original attributes
- Three general methodologies:
 - Feature Extraction
 - ◆ domain-specific
 - Mapping Data to New Space
 - Feature Construction
 - ◆ combining features

Mapping Data to a New Space

- **Fourier transform**
- **Wavelet transform**

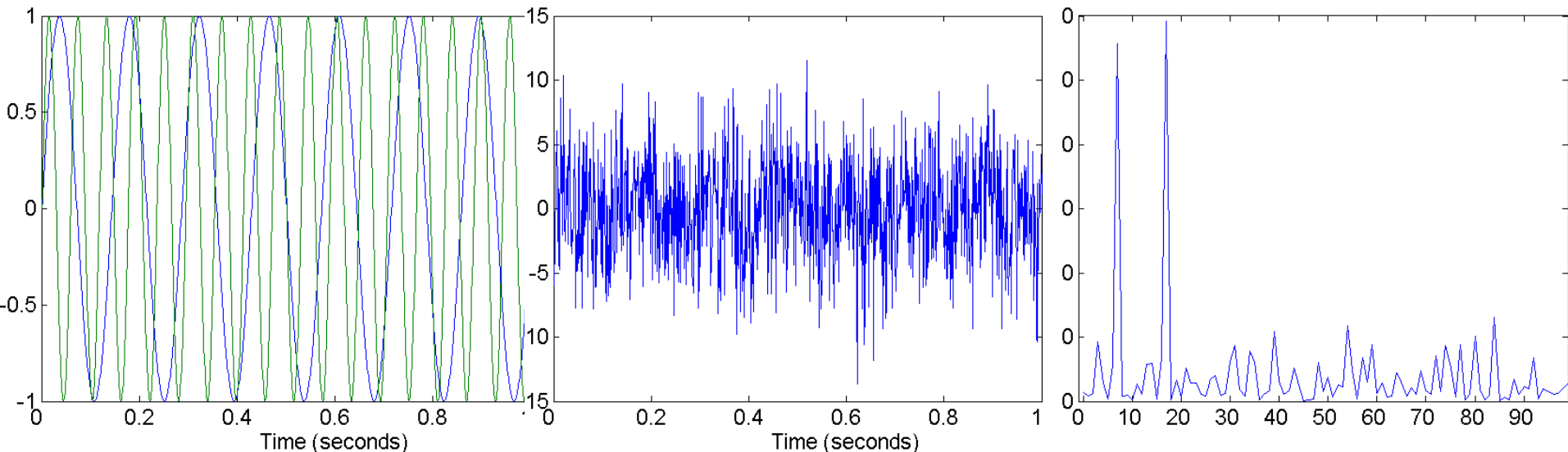

Two Sine Waves

Two Sine Waves + Noise

Frequency

Discretization Using Class Labels

- Entropy based approach

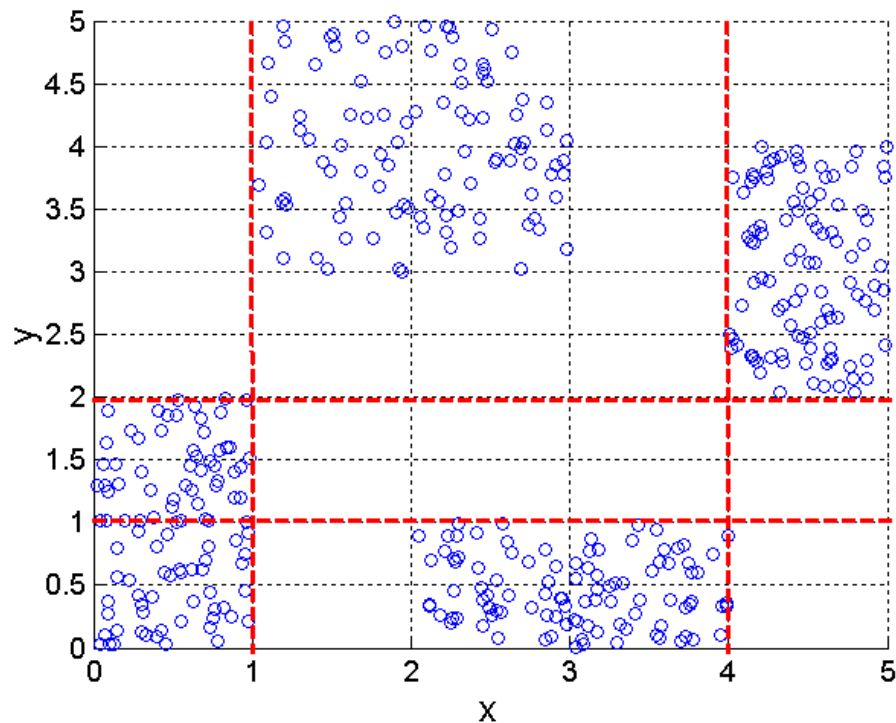

3 categories for both x and y

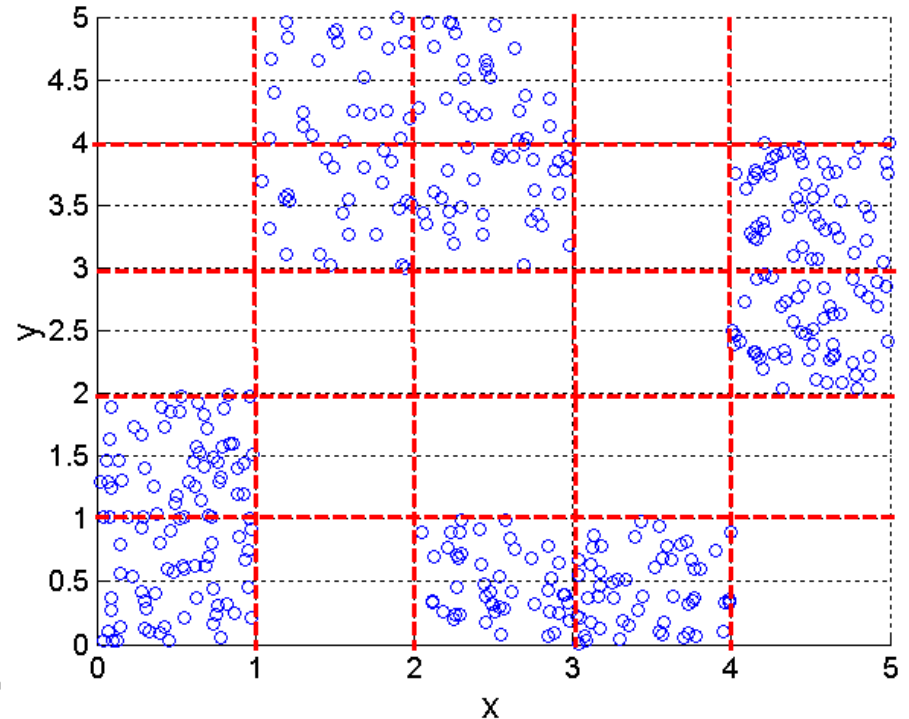

5 categories for both x and y

Discretization Without Using Class Labels

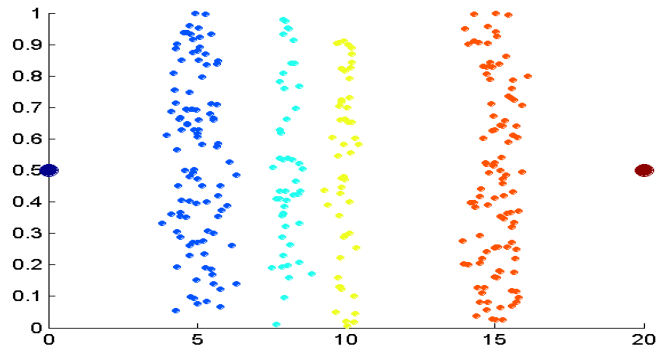

Data

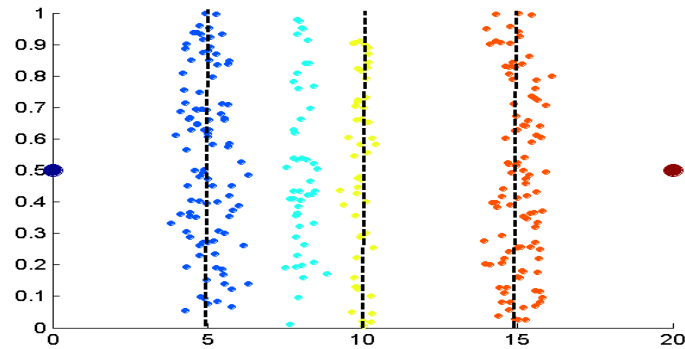

Equal interval width

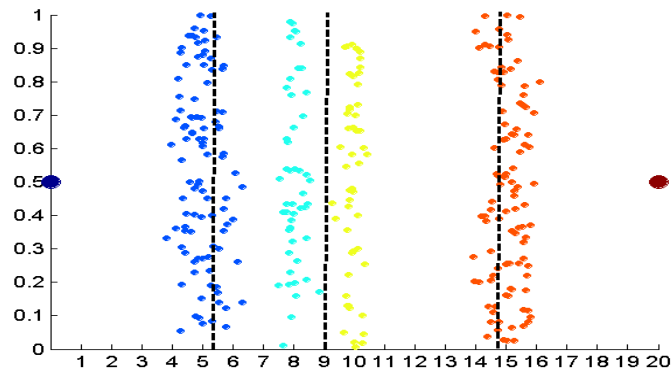

Equal frequency

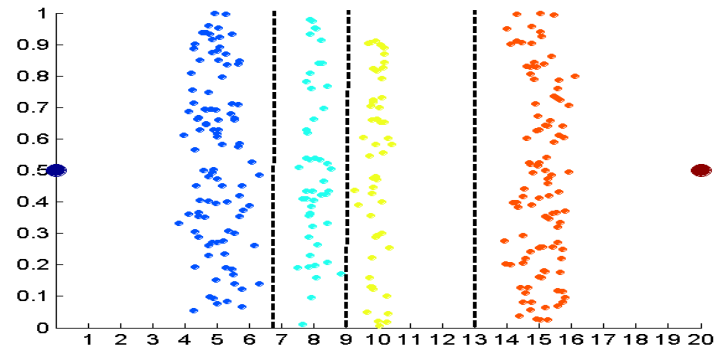

K-means

Attribute Transformation

- A function that maps the entire set of values of a given attribute to a new set of replacement values such that each old value can be identified with one of the new values
 - Simple functions: x^k , $\log(x)$, e^x , $|x|$
 - Standardization and Normalization

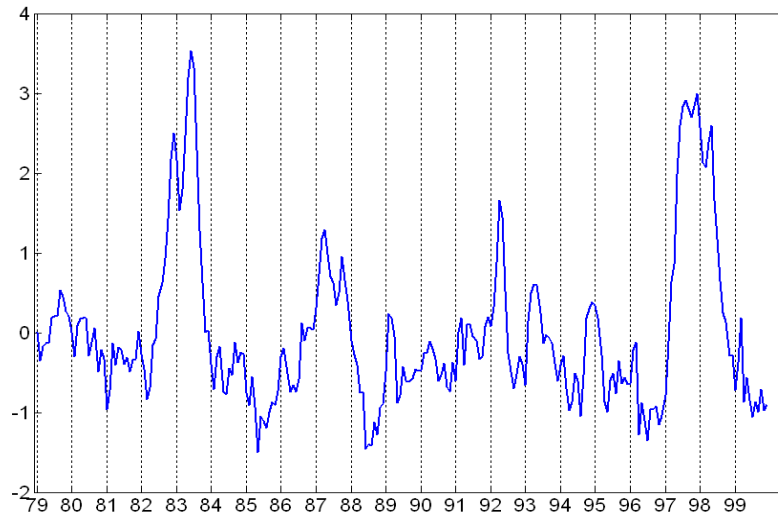

Similarity and Dissimilarity

- Similarity
 - Numerical measure of how alike two data objects are.
 - Is higher when objects are more alike.
 - Often falls in the range $[0,1]$
- Dissimilarity
 - Numerical measure of how different are two data objects
 - Lower when objects are more alike
 - Minimum dissimilarity is often 0
 - Upper limit varies
- Proximity refers to a similarity or dissimilarity

Similarity/Dissimilarity for Simple Attributes

p and q are the attribute values for two data objects.

Attribute Type	Dissimilarity	Similarity
Nominal	$d = \begin{cases} 0 & \text{if } p = q \\ 1 & \text{if } p \neq q \end{cases}$	$s = \begin{cases} 1 & \text{if } p = q \\ 0 & \text{if } p \neq q \end{cases}$
Ordinal	$d = \frac{ p-q }{n-1}$ <p>(values mapped to integers 0 to $n-1$, where n is the number of values)</p>	$s = 1 - \frac{ p-q }{n-1}$
Interval or Ratio	$d = p - q $	$s = -d, s = \frac{1}{1+d} \text{ or } s = 1 - \frac{d - \min_d}{\max_d - \min_d}$

Table 5.1. Similarity and dissimilarity for simple attributes

Euclidean Distance

- Euclidean Distance

$$dist = \sqrt{\sum_{k=1}^n (p_k - q_k)^2}$$

Where n is the number of dimensions (attributes) and p_k and q_k are, respectively, the k^{th} attributes (components) or data objects p and q .

- Standardization is necessary, if scales differ.

Euclidean Distance

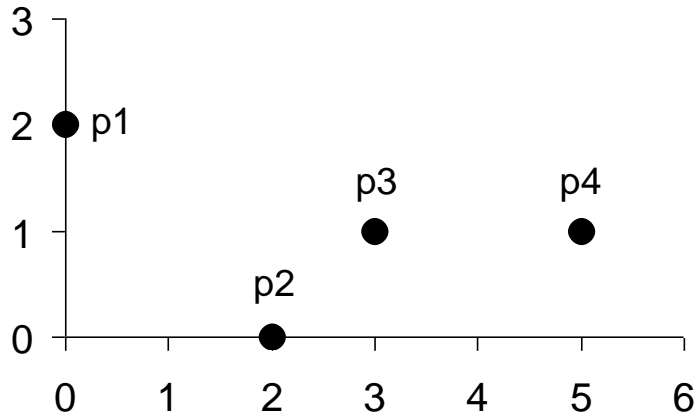

point	x	y
p1	0	2
p2	2	0
p3	3	1
p4	5	1

	p1	p2	p3	p4
p1	0	2.828	3.162	5.099
p2	2.828	0	1.414	3.162
p3	3.162	1.414	0	2
p4	5.099	3.162	2	0

Distance Matrix

Minkowski Distance

- Minkowski Distance is a generalization of Euclidean Distance

$$\mathit{dist} = \left(\sum_{k=1}^n |p_k - q_k|^r \right)^{\frac{1}{r}}$$

Where r is a parameter, n is the number of dimensions (attributes) and p_k and q_k are, respectively, the k th attributes (components) or data objects p and q .

Minkowski Distance: Examples

- $r = 1$. City block (Manhattan, taxicab, L_1 norm) distance.
 - A common example of this is the Hamming distance, which is just the number of bits that are different between two binary vectors
- $r = 2$. Euclidean distance
- $r \rightarrow \infty$. “supremum” (L_{\max} norm, L_{∞} norm) distance.
 - This is the maximum difference between any component of the vectors
- Do not confuse r with n , i.e., all these distances are defined for all numbers of dimensions.

Minkowski Distance

point	x	y
p1	0	2
p2	2	0
p3	3	1
p4	5	1

L1	p1	p2	p3	p4
p1	0	4	4	6
p2	4	0	2	4
p3	4	2	0	2
p4	6	4	2	0

L2	p1	p2	p3	p4
p1	0	2.828	3.162	5.099
p2	2.828	0	1.414	3.162
p3	3.162	1.414	0	2
p4	5.099	3.162	2	0

L_{∞}	p1	p2	p3	p4
p1	0	2	3	5
p2	2	0	1	3
p3	3	1	0	2
p4	5	3	2	0

Distance Matrix

Mahalanobis Distance

$$\mathit{mahalanobis}(p, q) = (p - q) \Sigma^{-1} (p - q)^T$$

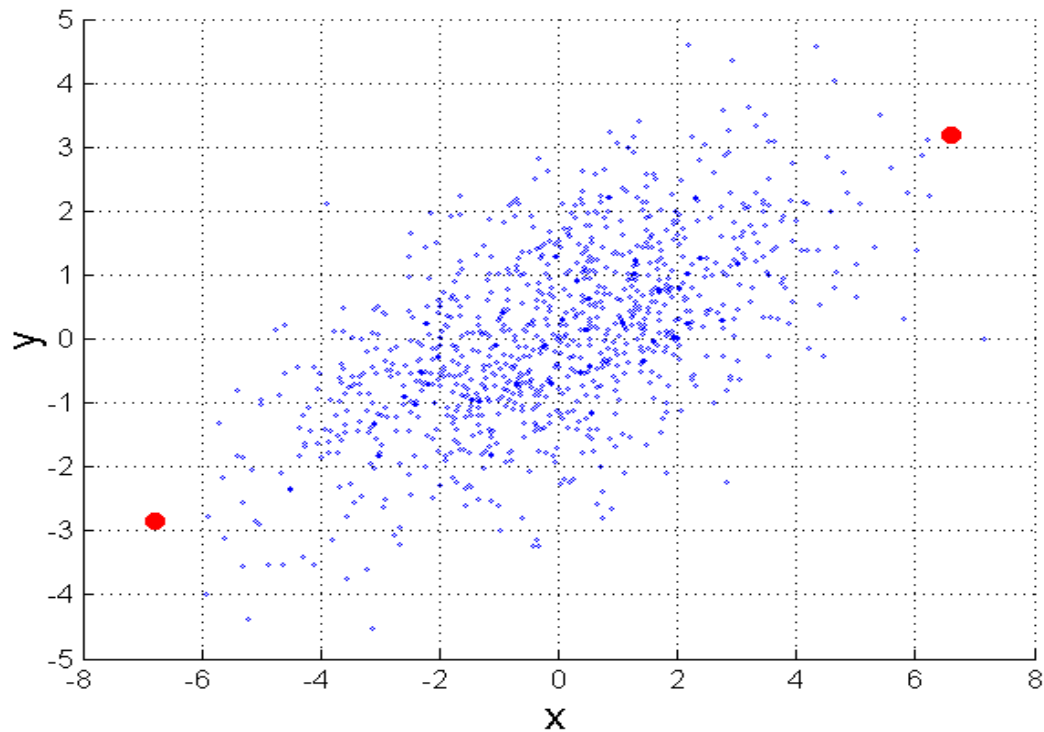

Σ is the covariance matrix of the input data X

$$\Sigma_{j,k} = \frac{1}{n-1} \sum_{i=1}^n (X_{ij} - \bar{X}_j)(X_{ik} - \bar{X}_k)$$

For red points, the Euclidean distance is 14.7, Mahalanobis distance is 6.

Mahalanobis Distance

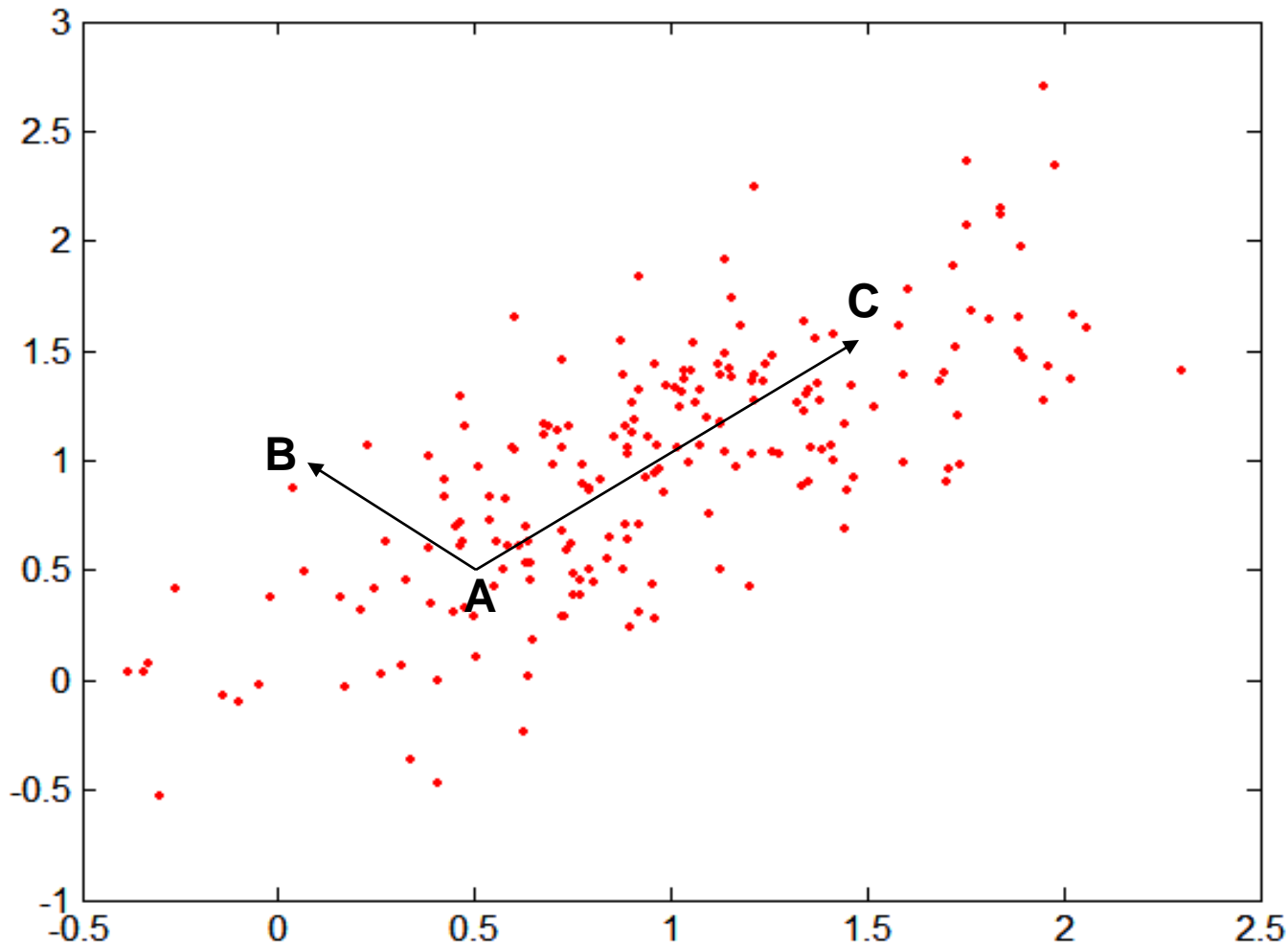

Covariance Matrix:

$$\Sigma = \begin{bmatrix} 0.3 & 0.2 \\ 0.2 & 0.3 \end{bmatrix}$$

A: (0.5, 0.5)

B: (0, 1)

C: (1.5, 1.5)

Mahal(A,B) = 5

Mahal(A,C) = 4

Common Properties of a Distance

- Distances, such as the Euclidean distance, have some well known properties.

1. $d(p, q) \geq 0$ for all p and q and $d(p, q) = 0$ only if $p = q$. (Positive definiteness)
2. $d(p, q) = d(q, p)$ for all p and q . (Symmetry)
3. $d(p, r) \leq d(p, q) + d(q, r)$ for all points p, q , and r . (Triangle Inequality)

where $d(p, q)$ is the distance (dissimilarity) between points (data objects), p and q .

- A distance that satisfies these properties is a **metric**

Common Properties of a Similarity

- Similarities, also have some well known properties.
 1. $s(p, q) = 1$ (or maximum similarity) only if $p = q$.
 2. $s(p, q) = s(q, p)$ for all p and q . (Symmetry)

where $s(p, q)$ is the similarity between points (data objects), p and q .

Similarity Between Binary Vectors

- Common situation is that objects, p and q , have only binary attributes

- Compute similarities using the following quantities

M_{01} = the number of attributes where p was 0 and q was 1

M_{10} = the number of attributes where p was 1 and q was 0

M_{00} = the number of attributes where p was 0 and q was 0

M_{11} = the number of attributes where p was 1 and q was 1

- Simple Matching and Jaccard Coefficients

SMC = number of matches / number of attributes

$$= (M_{11} + M_{00}) / (M_{01} + M_{10} + M_{11} + M_{00})$$

J = number of 11 matches / number of not-both-zero attributes values

$$= (M_{11}) / (M_{01} + M_{10} + M_{11})$$

SMC versus Jaccard: Example

$$p = 1000000000$$

$$q = 0000001001$$

$M_{01} = 2$ (the number of attributes where p was 0 and q was 1)

$M_{10} = 1$ (the number of attributes where p was 1 and q was 0)

$M_{00} = 7$ (the number of attributes where p was 0 and q was 0)

$M_{11} = 0$ (the number of attributes where p was 1 and q was 1)

$$\text{SMC} = (M_{11} + M_{00}) / (M_{01} + M_{10} + M_{11} + M_{00}) = (0+7) / (2+1+0+7) = 0.7$$

$$J = (M_{11}) / (M_{01} + M_{10} + M_{11}) = 0 / (2 + 1 + 0) = 0$$

Cosine Similarity

- If d_1 and d_2 are two document vectors, then

$$\cos(d_1, d_2) = (d_1 \bullet d_2) / \|d_1\| \|d_2\| ,$$

where \bullet indicates vector dot product and $\|d\|$ is the length of vector d .

- Example:

$$d_1 = 3 \ 2 \ 0 \ 5 \ 0 \ 0 \ 0 \ 2 \ 0 \ 0$$

$$d_2 = 1 \ 0 \ 0 \ 0 \ 0 \ 0 \ 0 \ 1 \ 0 \ 2$$

$$d_1 \bullet d_2 = 3*1 + 2*0 + 0*0 + 5*0 + 0*0 + 0*0 + 0*0 + 2*1 + 0*0 + 0*2 = 5$$

$$\|d_1\| = (3^2 + 2^2 + 0^2 + 5^2 + 0^2 + 0^2 + 0^2 + 2^2 + 0^2 + 0^2)^{0.5} = (42)^{0.5} = 6.481$$

$$\|d_2\| = (1^2 + 0^2 + 0^2 + 0^2 + 0^2 + 0^2 + 0^2 + 1^2 + 0^2 + 2^2)^{0.5} = (6)^{0.5} = 2.245$$

$$\cos(d_1, d_2) = .3150$$

Extended Jaccard Coefficient (Tanimoto)

- Variation of Jaccard for continuous or count attributes
 - Reduces to Jaccard for binary attributes

$$T(p, q) = \frac{p \bullet q}{\|p\|^2 + \|q\|^2 - p \bullet q}$$

Correlation

- Correlation measures the linear relationship between objects
- To compute correlation, we standardize data objects, p and q , and then take their dot product

$$p'_k = (p_k - \text{mean}(p)) / \text{std}(p)$$

$$q'_k = (q_k - \text{mean}(q)) / \text{std}(q)$$

$$\text{correlation}(p, q) = p' \bullet q'$$

Visually Evaluating Correlation

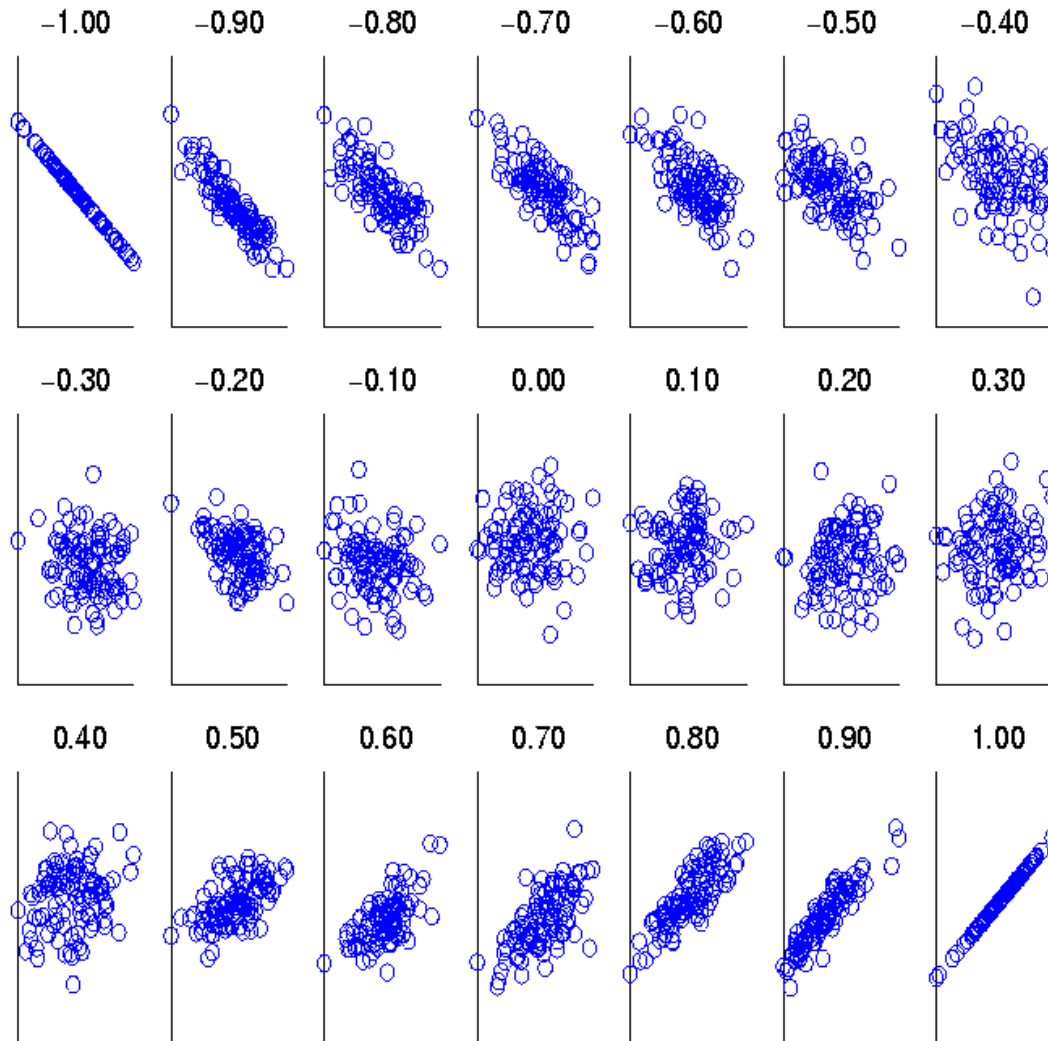

Scatter plots showing the similarity from -1 to 1.

General Approach for Combining Similarities

- Sometimes attributes are of many different types, but an overall similarity is needed.

1. For the k^{th} attribute, compute a similarity, s_k , in the range $[0, 1]$.
2. Define an indicator variable, δ_k , for the k^{th} attribute as follows:

$$\delta_k = \begin{cases} 0 & \text{if the } k^{th} \text{ attribute is a binary asymmetric attribute and both objects have} \\ & \text{a value of 0, or if one of the objects has a missing values for the } k^{th} \text{ attribute} \\ 1 & \text{otherwise} \end{cases}$$

3. Compute the overall similarity between the two objects using the following formula:

$$\text{similarity}(p, q) = \frac{\sum_{k=1}^n \delta_k s_k}{\sum_{k=1}^n \delta_k}$$

Using Weights to Combine Similarities

- May not want to treat all attributes the same.
 - Use weights w_k which are between 0 and 1 and sum to 1.

$$\text{similarity}(p, q) = \frac{\sum_{k=1}^n w_k \delta_k s_k}{\sum_{k=1}^n \delta_k}$$

$$\text{distance}(p, q) = \left(\sum_{k=1}^n w_k |p_k - q_k|^r \right)^{1/r}$$

Density

- Density-based clustering require a notion of density
- Examples:
 - Euclidean density
 - ◆ Euclidean density = number of points per unit volume
 - Probability density
 - Graph-based density

Euclidean Density – Cell-based

- Simplest approach is to divide region into a number of rectangular cells of equal volume and define density as # of points the cell contains

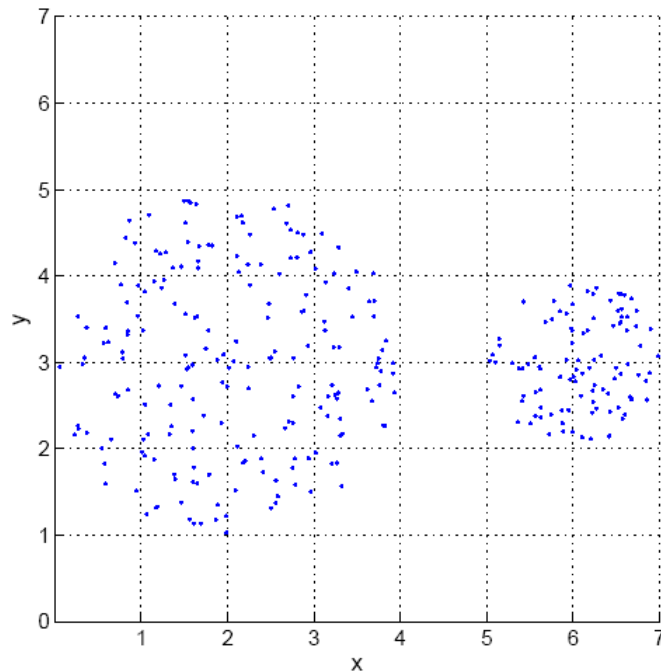

Figure 7.13. Cell-based density.

0	0	0	0	0	0	0
0	0	0	0	0	0	0
4	17	18	6	0	0	0
14	14	13	13	0	18	27
11	18	10	21	0	24	31
3	20	14	4	0	0	0
0	0	0	0	0	0	0

Table 7.6. Point counts for each grid cell.

Euclidean Density – Center-based

- Euclidean density is the number of points within a specified radius of the point

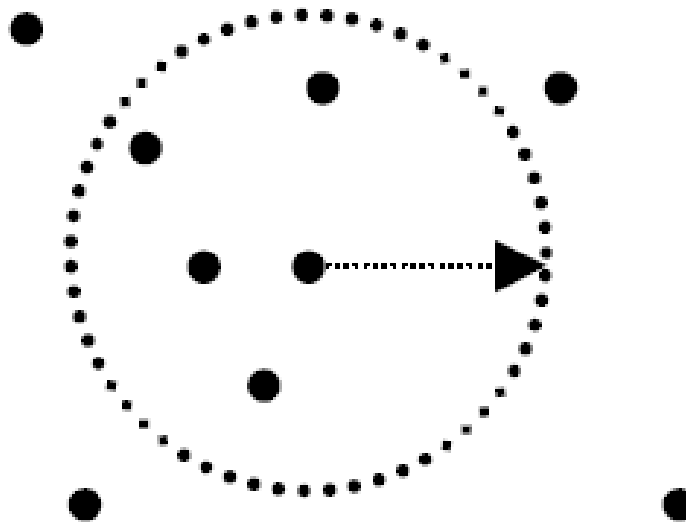

Figure 7.14. Illustration of center-based density.